

## VIALAB Operating instructions

## Document Change History

Vers.	Status:	Name:	Date:	Change:
V00		ULe, SSt	07-12-2017	Document issued
V01	Released	SSt	15-03-2018	Document released
V02	Released	SSt	10-10-2018	download information added, troubleshooting "Program Transfer To Pipette" added
V03	Released	ULe, SSt	09-01-2019	New Software V2.0
V04	Released	SSt	13-02-2019	System Requirements for VIALAB 2.0 changed

## Table of Contents

<b>1</b>	<b>Introduction</b>	<b>3</b>
1.1	Purpose	3
1.2	Scope	3
<b>2</b>	<b>System requirements</b>	<b>3</b>
2.1	Personal computer / Laptop	3
2.2	Compatibility	3
2.3	Programming Stand for electronic pipettes	3
2.4	Bluetooth module for VIAFLO/VOYAGER electronic pipettes	3
<b>3</b>	<b>Installation of VIALAB</b>	<b>4</b>
3.1	Preparation	4
3.2	First time installation	4
3.3	Running VIALAB without installation	4
<b>4</b>	<b>Settings</b>	<b>5</b>
4.1	VIALAB Settings and Information	5
4.2	Update VIALAB	6
<b>5</b>	<b>Main Menu</b>	<b>7</b>
5.1	Information and saving options	7
<b>6</b>	<b>Programming</b>	<b>8</b>
6.1	Overview	8
6.2	Material	10
6.3	Method	12
6.4	Simulation	18
6.5	Transfer	19
6.5.1	Connect pipette	19
6.5.2	Transfer	19
<b>7</b>	<b>Labware Library</b>	<b>20</b>
7.1	Reservoirs	20
7.2	Plates	22
7.3	Tube Rack	24
7.4	COMBI Base	25
7.5	COMBI System	26
<b>8</b>	<b>Trouble Shooting</b>	<b>27</b>

## 1 Introduction

### 1.1 Purpose

VIALAB enables creating programs and transfers programs to INTEGRA VIAFLO/VOYAGER electronic pipettes. VIALAB programs for use with ASSIST PLUS only.

Programming in VIALAB can be done without a connected pipette.

### 1.2 Scope

These operating instructions describe the installation and operation of VIALAB V 2.0 or higher.

## 2 System requirements

### 2.1 Personal computer / Laptop

CPU:	INTEL or AMD (not older than 5 years)
USB port:	2.0 / 3.0
Bluetooth:	optional
Memory:	> 4 GB
Internet access:	recommended during installation, required for updates
Operating system:	MS Windows 8.1, MS Windows 10.x
Framework:	Microsoft .NET 4.7.2 (or later)

### 2.2 Compatibility

Device:	Serial No.:	Pipette Firmware connectable to	
		VIALAB V 1.0.x	VIALAB V 2.0.x
VIAFLO electronic multichannel pipette	7000000 and higher	4.12 and higher	4.20 and higher
VOYAGER electronic tip spacing pipette	7000000 and higher	4.12 and higher	4.20 and higher

### 2.3 Programming Stand for electronic pipettes

The Programming Stand (PN 4211) needs to be connected to the USB port of your PC

It can be used to charge the pipette battery and enables the communication between the PC and the pipette.

### 2.4 Bluetooth module for VIAFLO/VOYAGER electronic pipettes

For a wireless communication the Bluetooth pipette module (PN 4221) can be used instead of the USB Programming Stand.

## 3 Installation of VIALAB

### 3.1 Preparation

Download VIALAB from [www.integra-biosciences.com/download-vialab](http://www.integra-biosciences.com/download-vialab). Register, download the ZIP file and unzip the file.

### 3.2 First time installation

Log in to your computer with administrator log in.

- Run the setup routine and choose a directory where VIALAB should be installed (e.g. C:\Programs\Integra Biosciences AG\VIALAB). If you are not logged in as administrator, you may be prompted for the administrator login.
- VIALAB can also be installed on a network drive. Choose your network drive during installation.

### 3.3 Running VIALAB without installation

VIALAB can be run from a USB drive or any other program folder. Simply copy the installed directory (e.g. C:\Programs\Integra Biosciences AG\VIALAB) to your specific drive.

## 4 Settings

### 4.1 VIALAB Settings and Information



Click on the Settings button in the top right corner. Use the VIALAB Settings to define your preferences and get additional information.

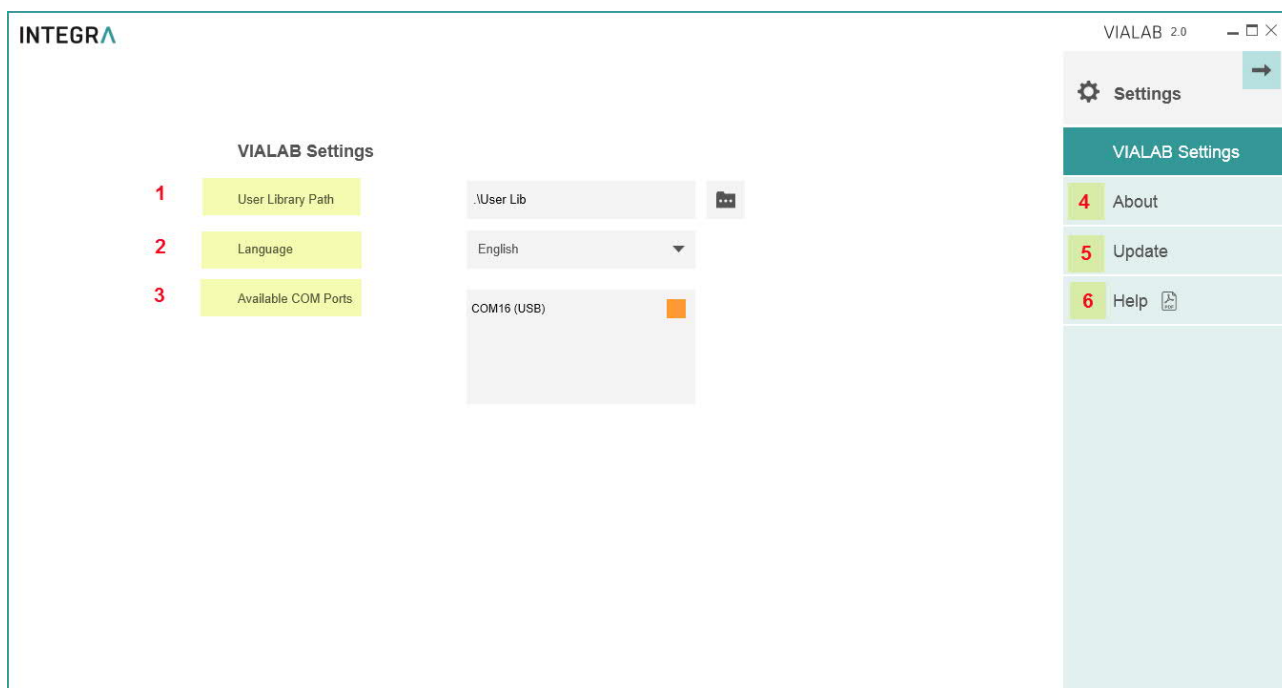

**1 User Library Path:** Define the storage path of your labware library.

**2 Language:** Choose your preferred language.

**3 Available COM Ports:** Shows all available communication ports.

**4 About:** Information about the VIALAB software version and the INTEGRA contact data

**5 Update:** Check for new updates, see 4.2.

**6 Help:** Download the latest VIALAB operating instructions.

## 4.2 Update VIALAB

If an update for VIALAB is available and you are connected to the internet you can check for new updates.

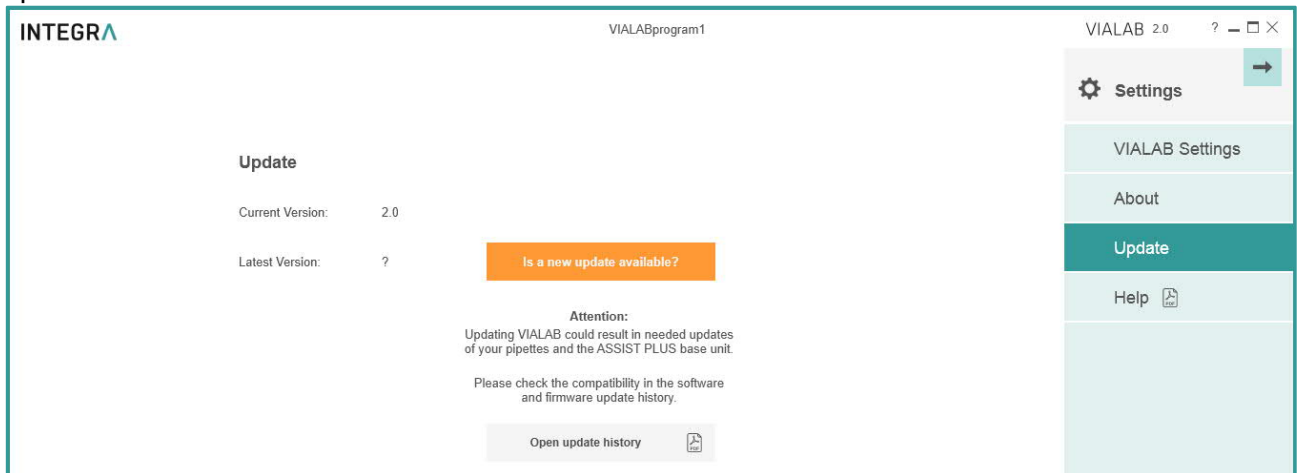

Click on Open update history to download information about software versions of VIALAB and VIALINK as well as firmware information of VIAFLO/VOYAGER pipettes and ASSIST / ASSIST PLUS.

## 5 Main Menu

### 5.1 Information and saving options



Click on the Menu button in the top left corner to open the main menu. Here information about the program is displayed and saving options are listed.

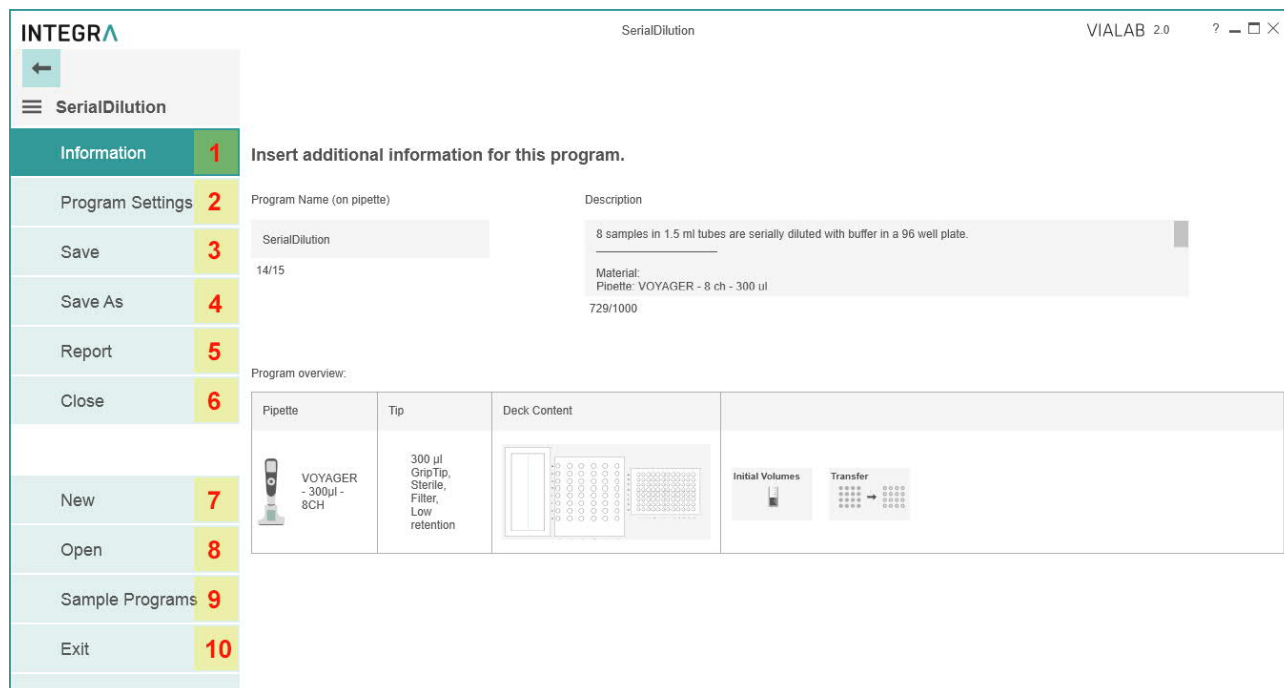

**1 Information:** change the Program name and add a description, if desired.

**2 Program Settings:** define the clearance height and offsets of each deck position for your program.

**3 Save:** save your program.

**4 Save As:** save you program under a new name.

**5 Report:** generate a printable PDF-report of your program, e. g. for standard operating procedures.

**6 Close:** close your program.

**7 New:** create a new program.

**8 Open:** open an existing program, recently used programs are listed.

**9 Sample Programs:** select and open a sample program.

**10 Exit:** exit VIALAB

## 6 Programming

### 6.1 Overview

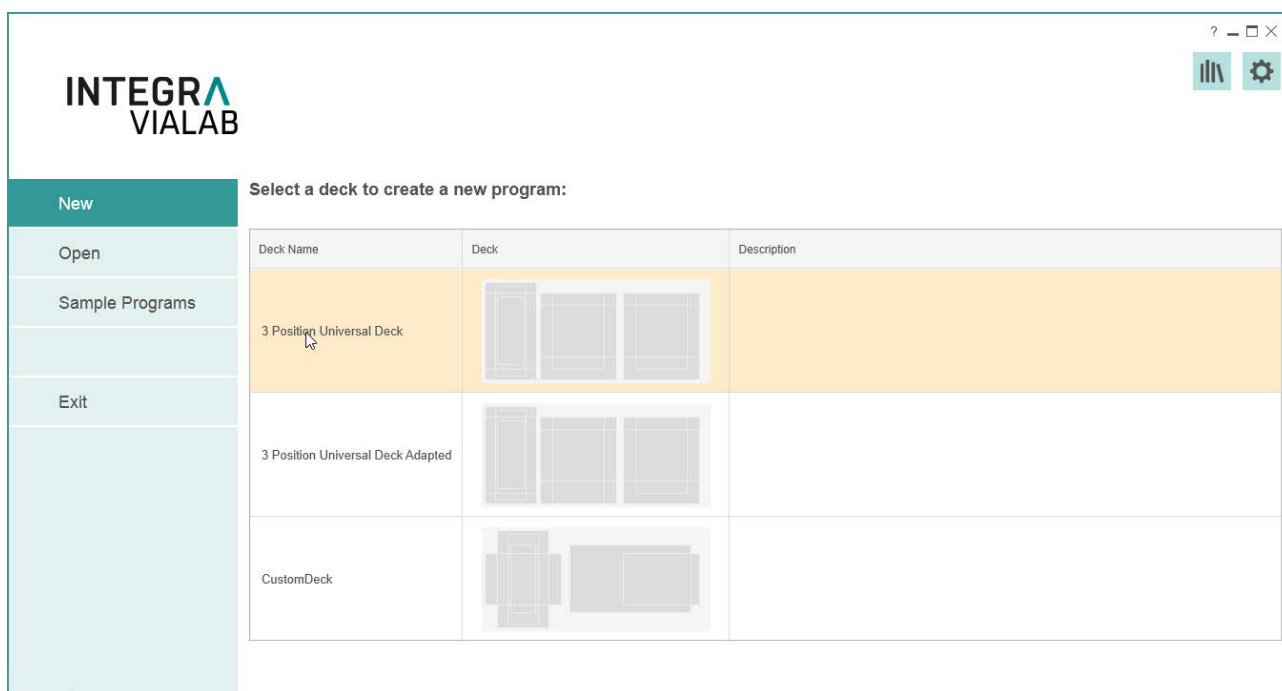

After starting VIALAB, you can create a new pipetting program, open an existing or recently used program or get started with a sample program.

To create a new program select first the deck you want to use, e.g. the 3 Position Universal Deck with one reservoir position and two spring loaded plate positions.



The program menu will be displayed:

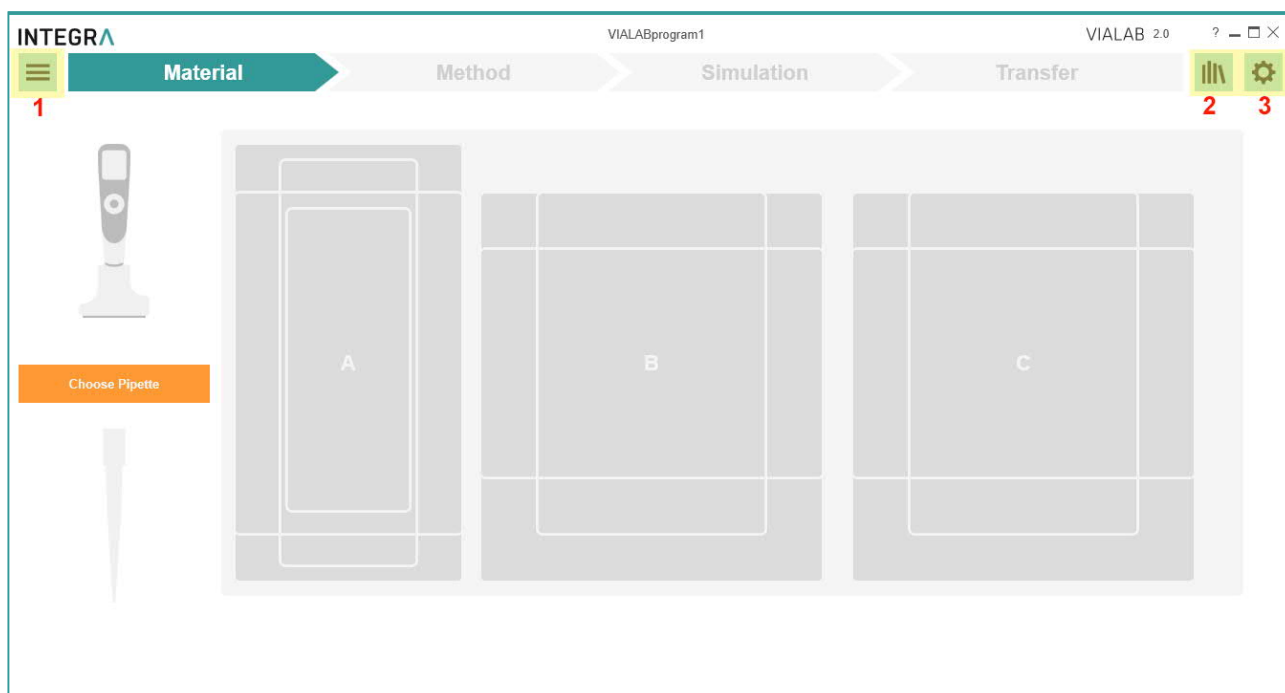

- 1 **Main Menu:** Information and saving options of the defined program (see chapter **Fehler! Verweisquelle konnte nicht gefunden werden.**)
- 2 **Library:** Labware library listing available decks, pipettes, tips, reservoirs, plates, tube racks, and COMBI systems with COMBI bases which can be used for a program. You can also define new reservoirs, plates, tube racks and COMBI systems. Alternatively, import already defined labware files to the labware library.
- 3 **Gear wheel:** Settings and updates of VIALAB.

The table below shows the different sections for creating a program. After one section is completed, the next can be defined.

Section	Description
Material	Choose the pipette with tips and the labware on the deck, e.g. the reservoir used as source container and the kind of well plates with orientation.
Method	Create your program that can contain up to 99 steps.
Simulation	Review a simulation of all steps in your pipetting program.
Transfer	Transfer the program to your pipette or reload an adapted program from the pipette.

## 6.2 Material

First click on the orange square to choose the pipette and afterwards select the GripTips. This enables the selection of the other labware used in the program.

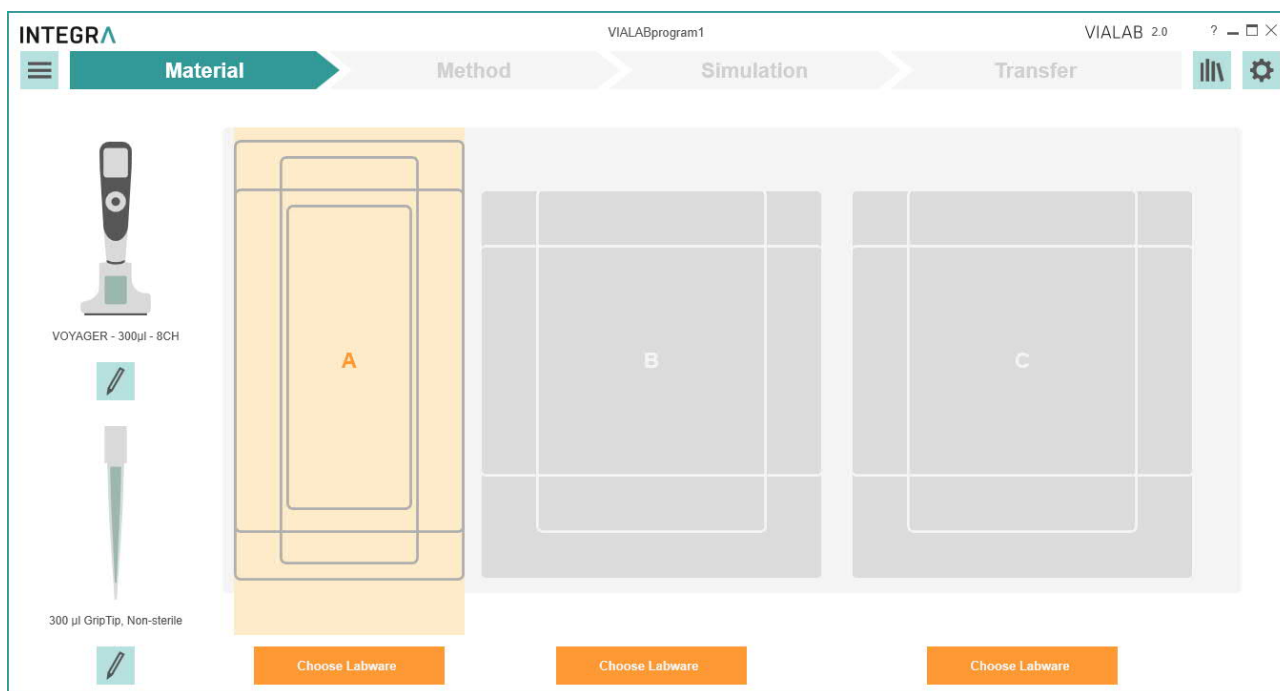

Click on an orange button to choose the predefined labware on all required positions.

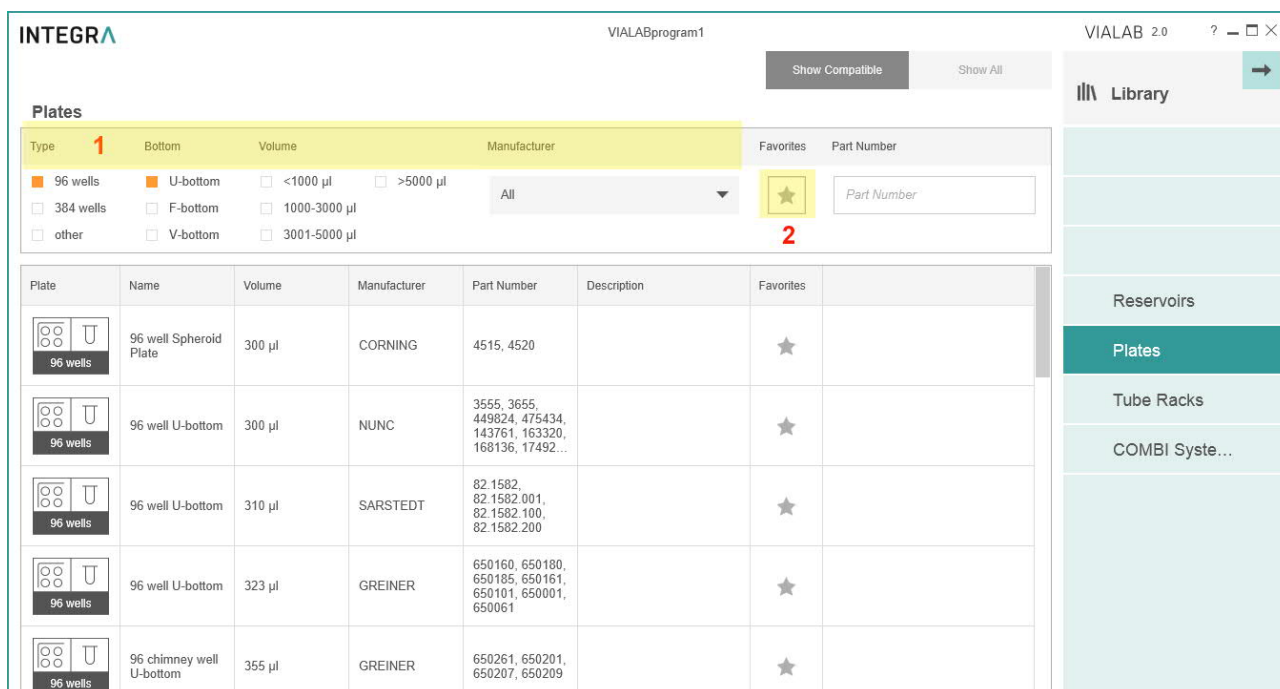

Select the desired properties or manufacturer (1) to quickly show reservoirs/plates/tube racks/COMBI Systems which are compatible with the selected pipette and deck position.

Click on the star (2) to show favorites only (to be defined in the labware library).

Scroll to one reservoir, plate, tube rack or COMBI System and select it by clicking on it.

Labware	Description
Reservoirs	Select an INTEGRA reservoir or define a new reservoir, see Library icon.
Plates	Select one of predefined, commercially available plates. Search for any plate or enter the part number directly, if known. Alternatively, define the dimensions of a new plate, see Library icon.
Tube Racks	Select a tube rack or define a new one, see Library icon.
COMBI System	To add a COMBI System, select a COMBI BASE and fill each selected column with modules, i.e. plates, tube racks or reservoirs and click on Apply COMBI System, see also section 7.5.

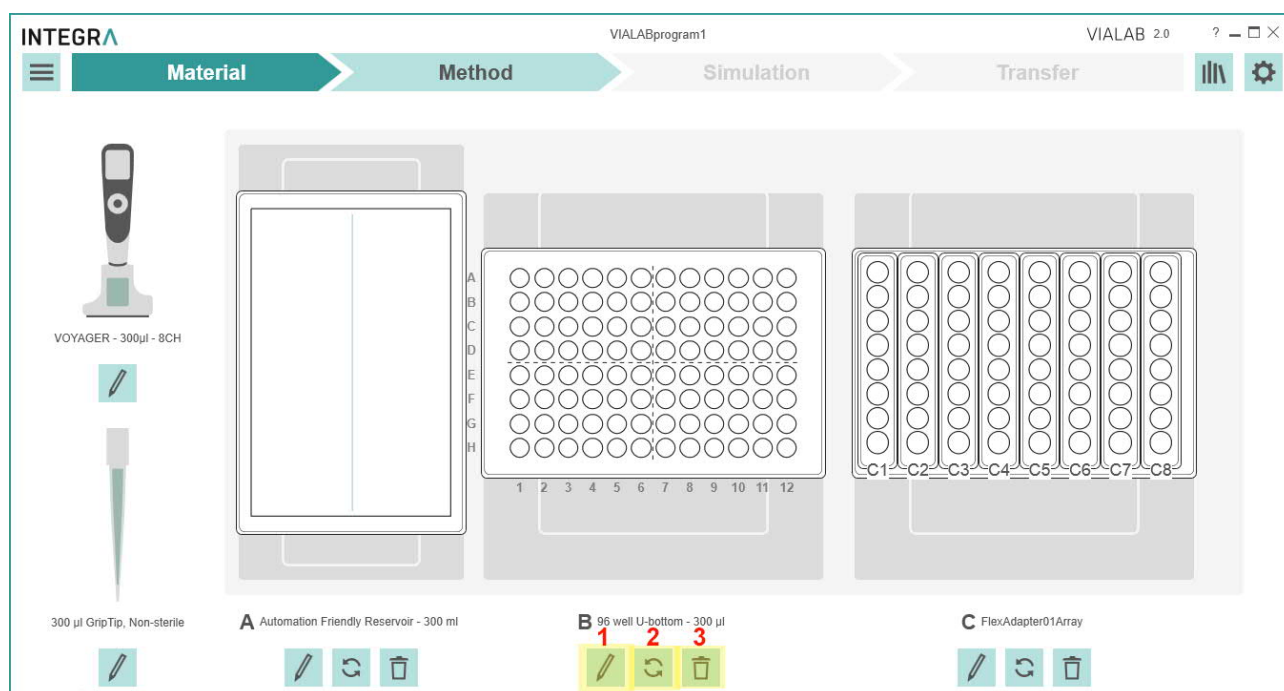

- 1 Edit:** Change the chosen labware.
- 2 Change orientation:** Rotate counterclockwise by 90° (all 4 possible orientations).
- 3 Delete:** Delete the selected labware on this position.

**Note:** Changing the material of an already defined program, e.g. pipette or plate orientation, will delete all subsequent program steps in the “Method” section, if they are not compatible with the previous settings.

## 6.3 Method

Your pipetting program is composed of several steps.

When you open the section Method the first time, the first step “Initial Volumes” is already preset and you are prompted to set the volumes of the labware which are already filled.

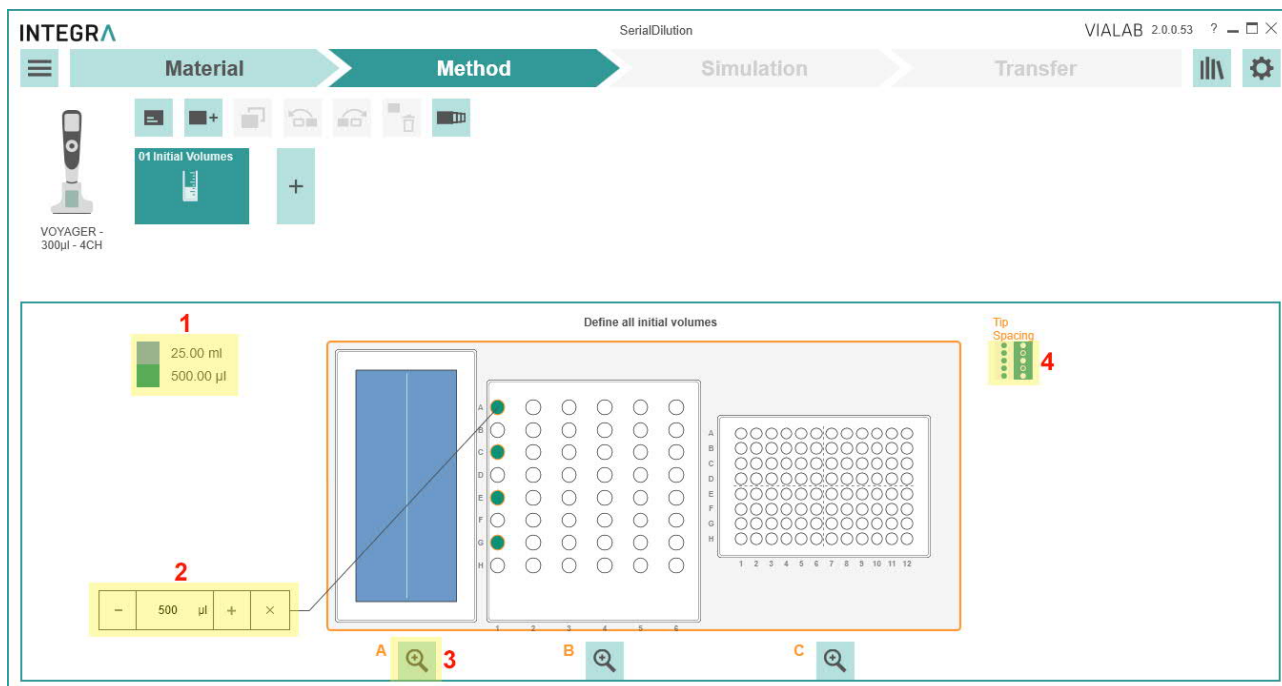

- 1 Color legend:** Shows the pre-fill volume of the labware on position A, B or C. Each color represents one pre-fill volume.

---

- 2 Pre-fill volume:** Click on the vessel which is already filled at the start of your program and enter the pre-fill volume.

---

- 3 Zoom:** Displays a close-up view of one deck position.

---

- 4 Tip spacing:** Choose a different tip spacing to change the filling pattern of your plate e.g. as shown with plate on position C (only for VOYAGER tip spacing pipettes).

Select the wells which are pre-filled at the start of your program via click or drag and drop. In the pop-up window you type in the dedicated volume in the given unit to assign a volume.

To view or edit the assigned volume select wells and the current volume is displayed. If needed, edit the volume or delete it.

# INTEGRA

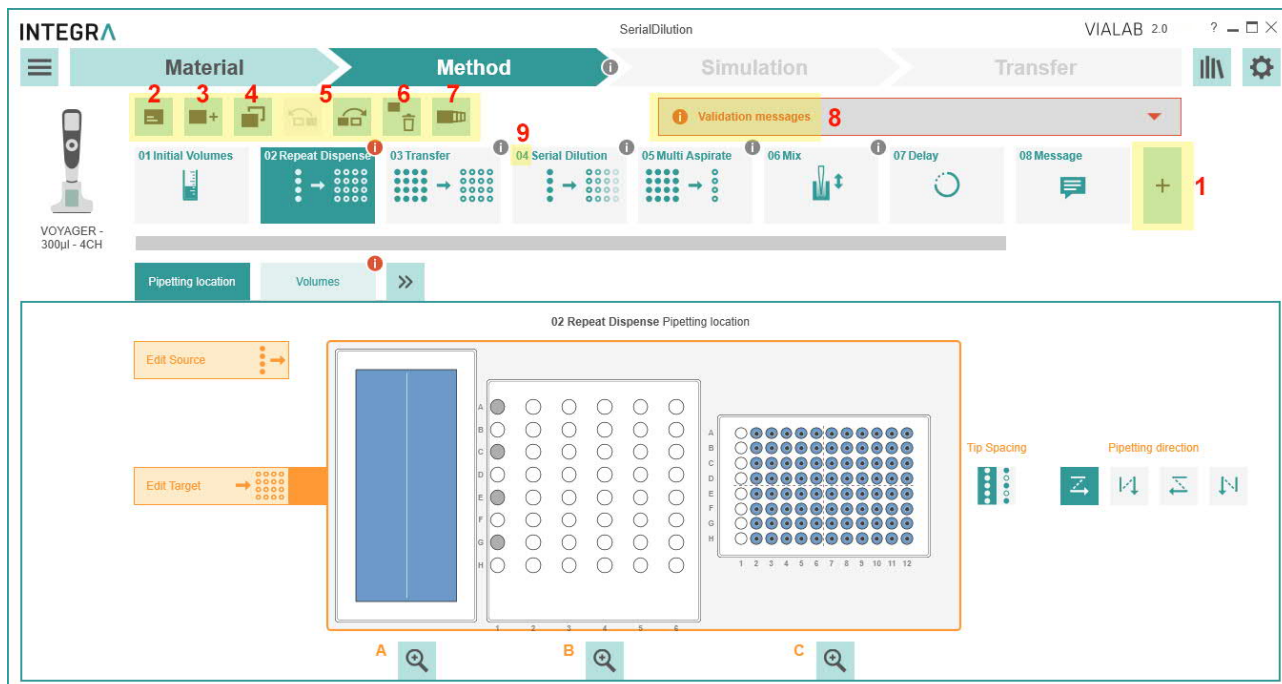

To add further steps click on a plus square (1, 3). To move, copy or delete steps click on the corresponding icon (4, 5, 6). The steps are processed sequentially according to the step number (9).



- 1 Plus square:** add a new step to the end of the method.
- 2 Add Description:** add a description for the current step. The first 15 characters are displayed at the bottom of the step icon.
- 3 Add Step:** add a new step after a selected step to the method.
- 4 Copy Step:** copy selected step to the end.
- 5 Move left/right:** move the selected step forwards or backwards.
- 6 Delete Step:** delete selected step.
- 7 Multi-Selection:** click on this button to select multiple steps in parallel to copy or delete them.
- 8 Validation messages:** click on this field for programming error details.
- 9 Step number:** the step number indicates the step sequence in the program.

Following steps are available:

Symbol	Step	Description
	Transfer	Transfers an equal number of samples from a source to target (N:N), e.g. plate copy.
	Repeat Dispense	Dispenses from one source into multiple targets (1:N), e.g. reagent addition
	Serial Dilution	Aspirates sample from a source and performs a serial dilution in the defined number of wells.
	Multi Aspirate	Collects a number of samples from one source and transfers into one target (N:1).
	Mix	Mixes a sample by pipetting up and down in the selected vessel.

Symbol	Step	Description
	Delay	Defines a pause between the last and the next step in seconds.
	Message	Pauses the program and displays a message. Three lines with 12 characters each are available.
	Volume Change	Enter the filling volume of the vessels e.g. after manual filling steps within a method. The volume defined in this step is an absolute volume. It does not take into account previous liquid handling steps.

Within one step, adjust the following parameters:

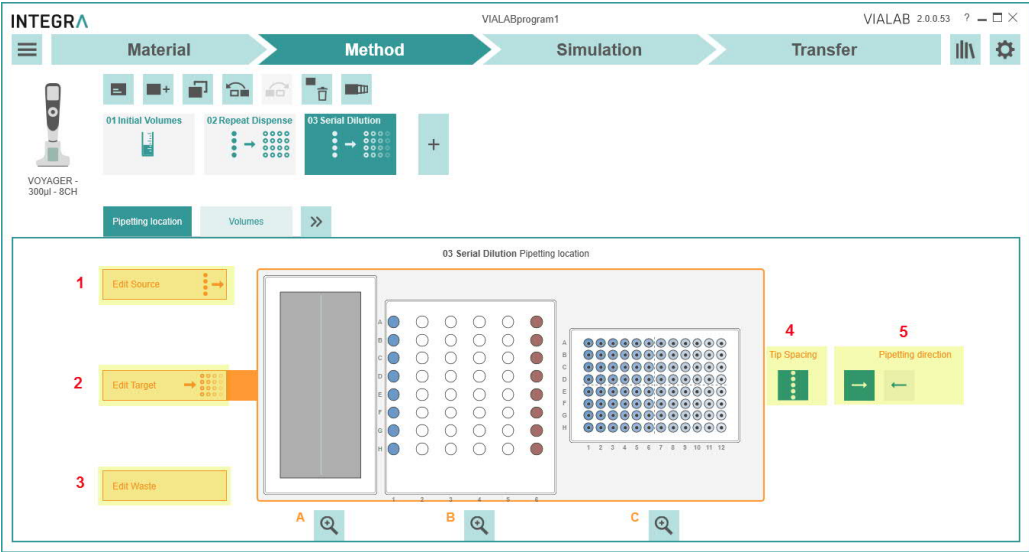
Parameter	Description
Pipetting location	<ul style="list-style-type: none"> <li>• <b>Edit Source (1)</b>: Click on the button and then select the wells (for plates on upmost well of column) where the liquid should be aspirated from. It will be colored.</li> <li>• <b>Edit Target (2)</b>: Click on the button and then select the wells (for plates on upmost well of column) where the liquid should be dispensed in. It will be marked with a black dot in the middle of the well.</li> <li>• <b>Edit Waste (3)</b>: Only for step “Serial Dilution” and if under Volumes “Last aspiration back to “Waste” was selected. Click on the button to select waste vessel location.</li> </ul>  <p>If needed, adapt the tip spacing (4) or the pipetting direction (5).</p>
Volumes	Move the slider up or down (1), type in the volume (2) or use the “+” and “-“ buttons to set the desired <b>Volume(s)</b> for the current step. An <b>Air Gap</b> can be set to aspirate a defined air volume after an aspiration of liquid.

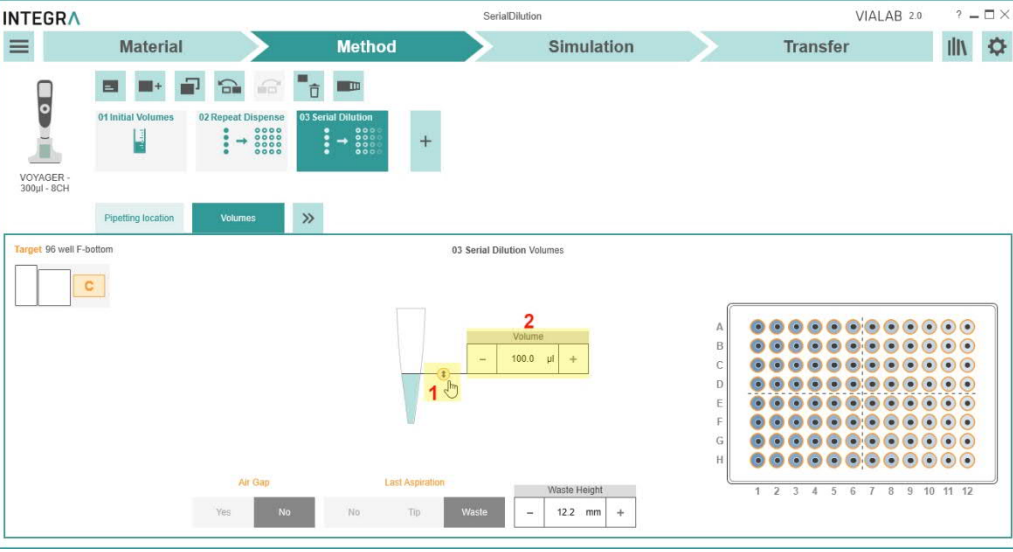
Parameter	Description	
		
Volumes	<b>Step Type</b>	<b>Volume description</b>
	Transfer	<p><b>Volume:</b> Define whether the volume is variable or fix for all transfers. If variable, select each individual column and assign a volume.</p>
	Repeat Dispense	<p><b>Post-Dispense Location:</b> Select if the post-dispense should be purged in the source vessel of aspiration or should remain in the tips.</p> <p><b>Reuse Post-Dispense:</b> Click on “Yes” if the post-dispense should remain in the tip and be used for the next aspiration.</p> <p><b>Dispense Type:</b> Click on “Single” to aspirate and dispense the selected volume or on “Multi” to aspirate a multiple of the selected volume and perform several dispenses.</p> <p><b>Volume:</b> Define whether the volume(s) to be dispensed (for every dispense step) is fix or variable. If variable, select each individual column and assign a volume. Set the pipetting direction. Additionally to the dispense volume set also the <b>Pre-Dispense</b> and the <b>Post-Dispense</b> volume.</p> <p>Note: We recommend a pre- and post-dispense volume of 8 % of the nominal volume of the pipette.</p>
	Serial Dilution	<p><b>Last Aspiration:</b></p> <ul style="list-style-type: none"> <li>- “No”: the last aspiration is not performed, the liquid remains in the last row.</li> <li>- “Tip”: the last aspiration remains in the tips that are ejected into the Waste bin.</li> <li>- “Waste”: the last aspiration is purged in a dedicated liquid waste vessel. The location has to be defined in “Pipetting location”.</li> </ul> <p><b>Volume:</b> The sample volume that will be transferred from well to well.</p>
	Multi Aspirate	<p><b>Aspirate Type:</b> Click on “Single” to aspirate only one volume or on “Multi” to perform several aspirations consecutively.</p> <p><b>Volume:</b> Define whether the volume to be aspirated (for every aspirate step) is fix or variable. If variable, select each individual column and assign a volume. Set the aspiration volume.</p>
Speeds	<ul style="list-style-type: none"> <li>• <b>Aspiration and Dispense Speed:</b> Set the aspiration and dispense speeds for this step. Set the slider to the appropriate speed from 1 (slow) to 10 (fast).</li> </ul>	

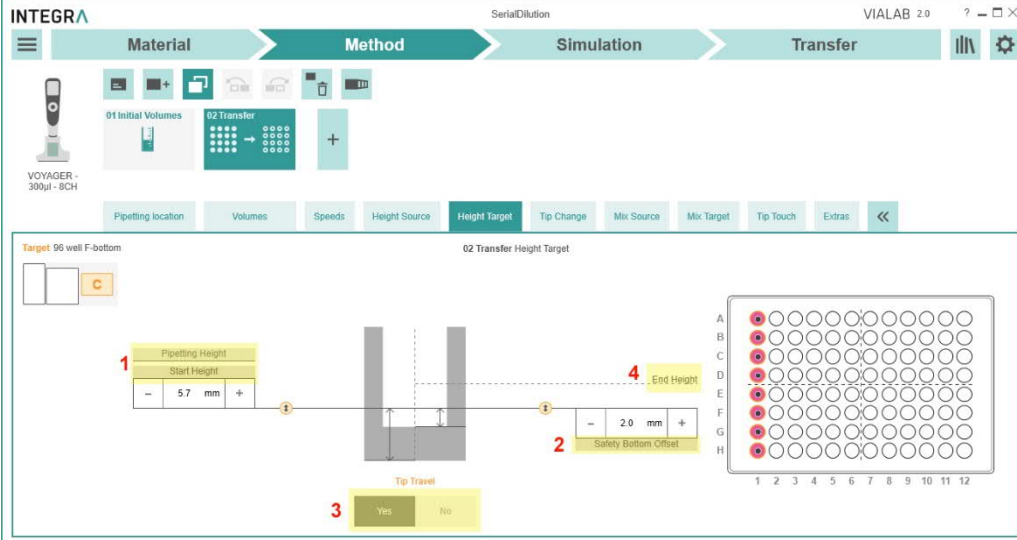
Parameter	Description
	<ul style="list-style-type: none"> <li>If necessary, adapt parameters for viscous and volatile liquids:               <ul style="list-style-type: none"> <li><b>Aspiration Delay:</b> A delay in seconds after aspiration before moving out of the liquid.</li> <li><b>Dispense Delay:</b> A delay in seconds after dispensing before moving out of the liquid.</li> <li><b>Exit Liquid Slowly:</b> The tips move slowly out of the liquid (for aspiration and for dispense)</li> </ul> </li> <li><b>Movement Speeds:</b> Changes the speeds of the Tower in X-direction, of the Pipette arm in Z-direction or the Pipette holder in Y-direction [1 (slow) to 10 (fast)].</li> </ul>
Height Source Height Target	<p>The calculated liquid level in the well is displayed to ease height definition graphically.</p> <p>Click on <b>Pipetting Height</b> or <b>Start Height (1)</b> and move the line up or down to enter the heights for aspiration/dispense referring to the deck (deck height is 0 mm). The <b>Safety Bottom Offset (2)</b> defines the minimum distance of the tips to the bottom of the labware.</p> <p>If the <b>Heights</b> are variable, define the pipetting heights for every column.</p> <p><b>Tip Travel (3):</b>            Movement of tip during one aspiration/dispense to compensate the decrease/increase of the liquid level. Recommended for high pipetting volumes in vessels with small diameter.            If Tip Travel is deactivated the aspiration/dispense is performed at a constant <b>Pipetting Height (1)</b>.</p>  <p>If Tip Travel is activated aspiration/dispense starts at the <b>Start Height (1)</b> and ends at the <b>End Height (4)</b>, which is calculated automatically according to the labware dimensions and pipetting volume.</p> <p>Note: It is possible to fine-tune the Pipetting Height / Start Height directly on the pipette to optimize the heights according to the used liquid (see ASSIST PLUS Operating Instructions chapter 5.4 “Adjust heights and positions”).</p>
Tip Change	<p>Set if and when tips should be changed.</p> <p><b>Continue next step without change:</b> no tip ejection after program step. Same tips will be used for next step.</p> <p><b>After step complete:</b> change tips after completing the current step</p> <p><b>After each transfer/dispense/dilution:</b> change tips after each dispense</p> <p><b>Before each new aspiration:</b> change tips before each new aspiration</p>

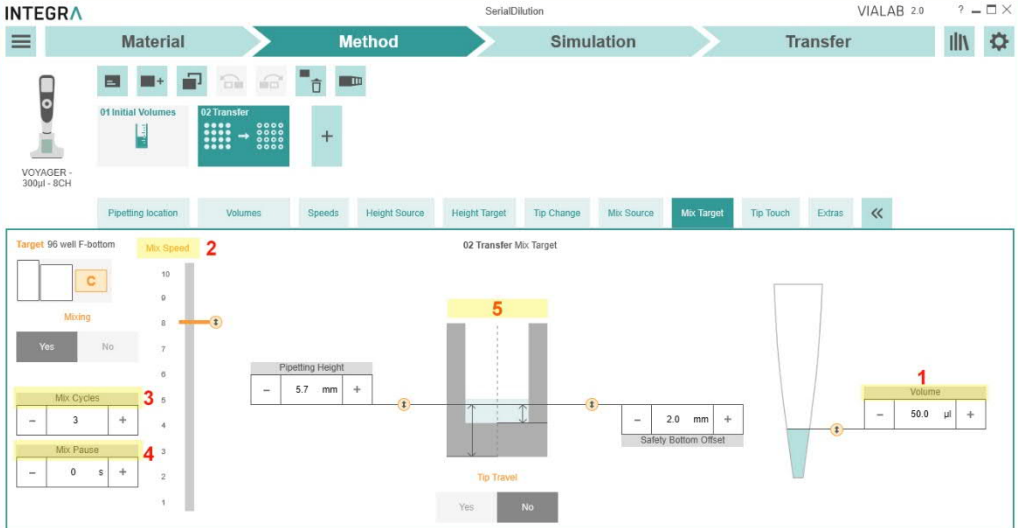
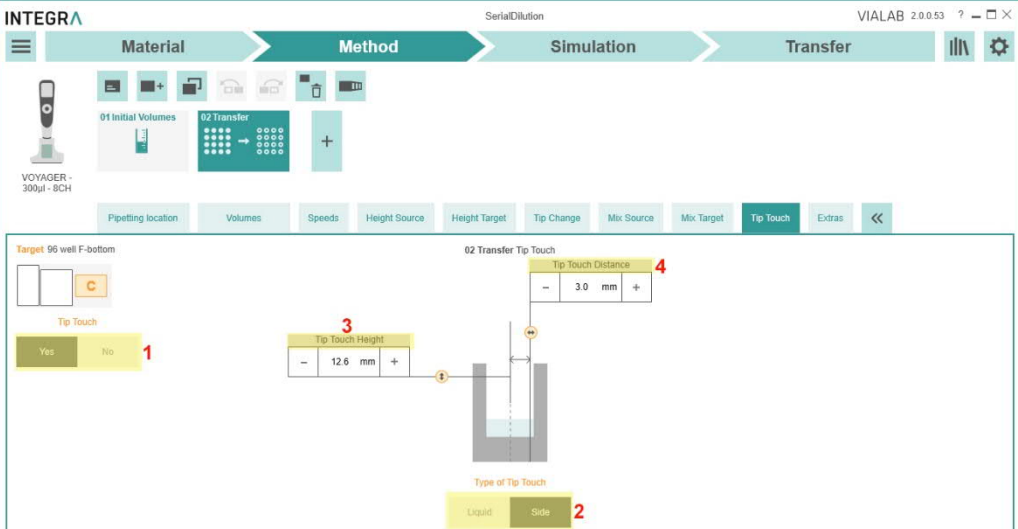

Parameter	Description
<p>Mix</p>	<p>Define, if the sample should be mixed in the source well before aspiration and in the target well after dispense. Define the mix <b>Volume (1)</b>, <b>Speed (2)</b>, the number of <b>Cycles (3)</b> and if a <b>Pause (4)</b> should be performed in between mixing cycles. Define the mixing <b>Heights (5)</b>.</p> 
<p>Tip touch</p>	<p>Set a tip touch (1) after dispensing to remove drops that may cling on the pipette tips. Set whether the tip touch should be performed into the <b>Liquid</b> or on the <b>Side (2)</b> of the wells. Enter the <b>Tip Touch Height (3)</b> and the <b>Distance (4)</b> to the vessel wall.</p> 

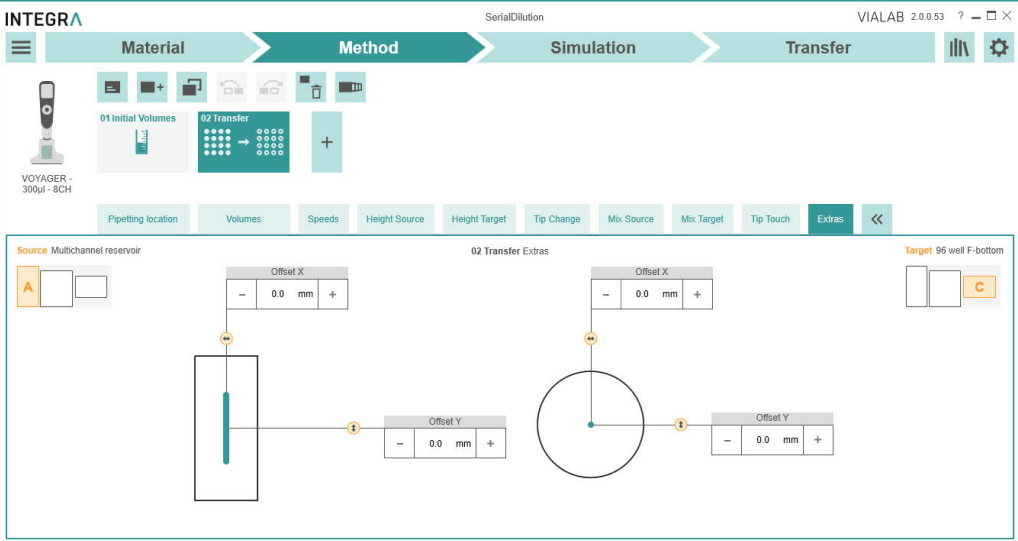
Parameter	Description
Extras	<p>Define a well <b>Offset</b>, if you want to pipette off the well center or even out of wells, e. g. for transwell plates.</p> 

**Note:** If red exclamation marks appears, the program contains errors. Click on “Validation messages” for further details.

## 6.4 Simulation

In the simulation window the deck with the defined labware is displayed. On the top all steps are listed. Click on the play button to start the simulation of your program. Watch the whole simulation or navigate between steps or stop the simulation (1).

To speed up the simulation to 2-, 4- or 8 fold speed, select the appropriate button (2). An estimation of the Total Time and the Total Tip Consumption is listed (3).

The simulation is displayed as top (4) and side (5) view of the deck.

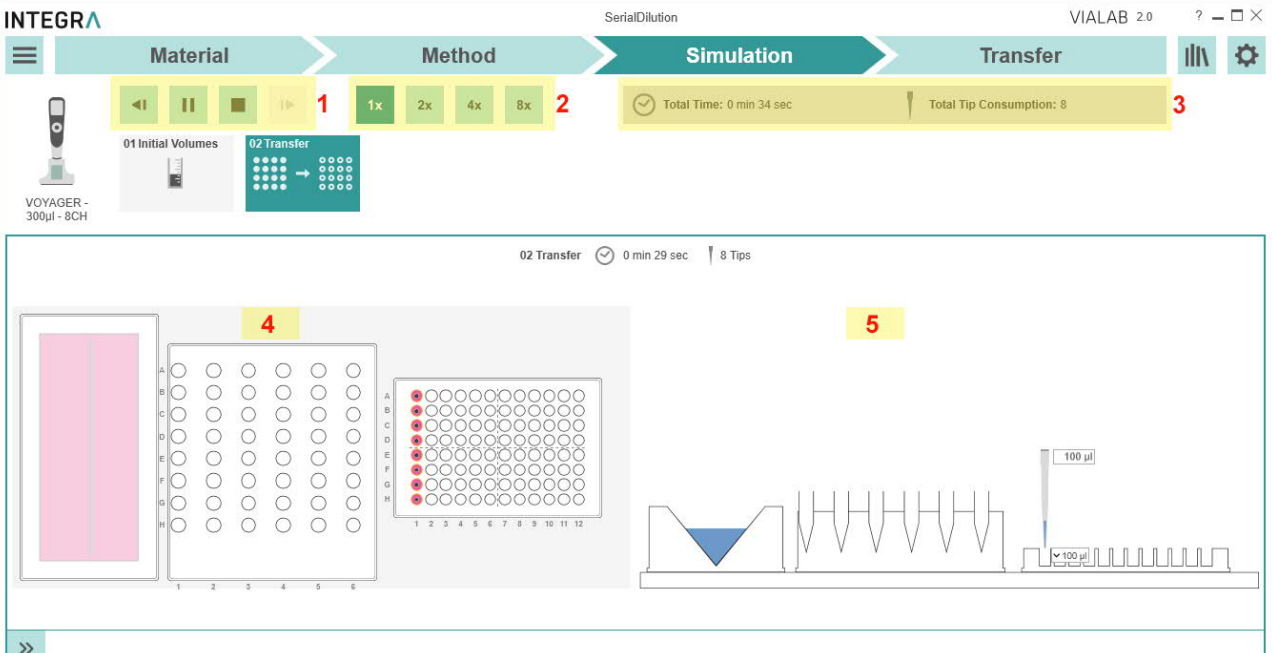

For all error-free programs a report is generated by clicking on the Main Menu and selecting “Report”. A report in pdf format with all settings of the program is generated.

## 6.5 Transfer

You should save your current program on your computer to have a backup or if you need to transfer the program to more than one pipette. Select the Main Menu button and click Save or Save As.

### 6.5.1 Connect pipette

#### Connection via Charging/Communication (USB) Stand (#4211)

Connect the USB cable to the stand and a free USB port on your computer. It is recommended to connect the stand to the mains power supply. Then hang the pipette onto the stand.

Go to the “Toolbox” of the pipette. In the menu “Communications” select “USB” on a VIAFLO/ VOYAGER electronic pipette. Stay in this menu for transfer.

#### Connection via Bluetooth (#4221)

Pipette and PC need to be paired for the first connection. Please refer to MS Windows Help to learn how to pair Bluetooth devices. The following pairing code may be required: 12345.

Go to the “Toolbox” of the pipette. In the menu “Communications” select “Bluetooth”.

### 6.5.2 Transfer

In VIALAB switch to the section “Transfer” for saving the program to the pipette.

Upon establishing the connection successfully the pipette details, such as pipette model, serial number and firmware version, are displayed on the right side. Other VIALAB programs already saved on the pipette are listed.

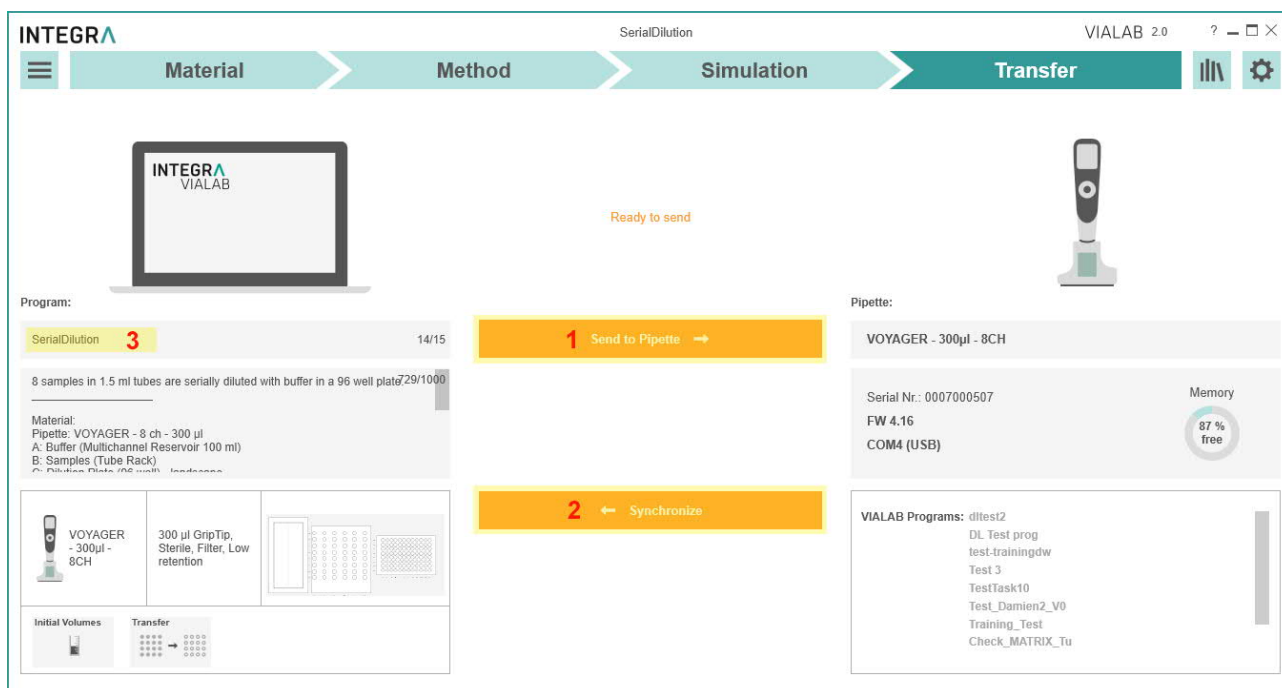

Send to Pipette (1) starts the transfer of the current program to the pipette. If certain parameters of the program are modified on the pipette (offsets, pipetting heights), synchronization of the program to VIALAB is possible (2).

To change the program display name on the pipette type in an alternative program name with max. 15 characters (3).

Successful saving or synchronization of the program to the pipette / to VIALAB is indicated by a temporary message at the bottom of the window.

## 7 Labware Library

You can access the labware library by clicking on the Library icon in the top right corner.

Within the labware library, you can define the dimensions of decks, reservoirs, plates, tube racks and COMBI Bases/Systems. Pipettes, GripTips and reservoirs from INTEGRA are already defined and cannot be modified.

### 7.1 Reservoirs

In the reservoir menu all predefined plates are listed. Select a desired property, e.g. Type, to quickly show already defined reservoirs of this property.

- 1 Reservoir:** the icon shows the number and shape of the wells and well bottom.
- 2 Name:** indicates the number and shape of the wells and well bottom, as well as other properties such as half-area.
- 3 Volume:** shows the maximal well volume of the reservoir or compartment as defined by the manufacturer.
- 4 Manufacturer:** name of the reservoir manufacturer
- 5 Part Number:** part number in accordance to the reservoir manufacturer
- 6 Description:** optional
- 7 Favorites:** select to mark as favorite. The material section in the program set-up has a filter to show only favorites.
- 8 Tools:** Edit/View details, Copy, Export or Delete the selected labware. It is not possible to edit or delete INTEGRA items. To modify other predefined labware, create a copy first and then edit the copy.

To add new reservoirs to the library, click on “Define new item”. In the Configure Reservoir menu enter a unique name, the manufacturer, the part number of the reservoir and a description, if applicable. The description can also be used for lab personal to identify the reservoir.

Enter the reservoir dimensions. You will be supported by live drawing of the defined reservoir.

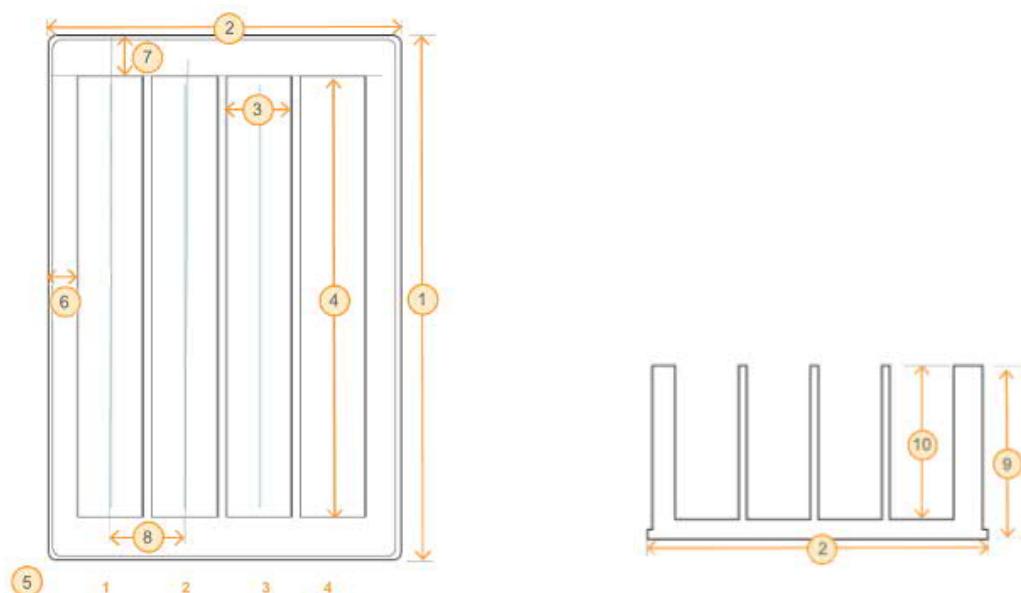

**Note:** Reservoirs are always set up with their compartment(s) in vertical direction.

Dimension	Description
Reservoir Width	The outside Width (1) of the reservoir including the bottom outside flanges, i.e. the displayed dimension from back to front.
Reservoir Length	The outside Length (2) of the reservoir including the bottom outside flanges, i.e. the displayed sideward dimension.
Compartment Width	The width of the compartments, i. e. the inner sideward dimensions (3).
Compartment Length	The length of the compartments, i. e. the inner distance from back to front (4)
Compartment Count	The number of the compartments (5), e. g. 4.
Left edge offset of First Compartment	The distance between the left outside edge of the reservoir and the left edge of the first compartment, including the bottom outside flange (6).
Top edge offset of First Compartment	The distance between the top outside edge of the reservoir and the top edge of the first compartment including the bottom outside flange (7).
Distance between Compartment Positions	The distance between the compartments, from the middle of one compartment to the middle of the next (8), e. g. 9 mm. This is the compartment width plus the spacing wall.
Type	Block. Rectangular flat bottom reservoirs can be defined.
Reservoir Height	The outside height (9) of the reservoir.
Compartment Depth	The inner depth (10) of the reservoir.
max. Volume	The maximal filling volume of one compartment.

## 7.2 Plates

In the plate menu all predefined plates are listed.

The screenshot shows the 'Plates' menu in the VIALAB 2.0 software. At the top right, there is a 'Define new item' button. Below it, a sidebar contains a 'Library' menu with options like Decks, Pipettes, Tips, Reservoirs, Plates (highlighted), Tube Racks, COMBI Base, COMBI System, and Import. The main area displays a table of predefined plates with columns for Type, Bottom, Volume, Manufacturer, Favorites, and Part Number. A table below lists specific plate configurations:

Plate	Name	Volume	Manufacturer	Part Number	Description	Favorites
12 wells	12 well F-bottom	6325 µl	TPP	92012, 92412, 92112		★
12 wells	12 well F-bottom	6900 µl	CORNING	3336, 3512, 3513		★
24 wells	24 well F-bottom	1900 µl	CORNING	3337, 3524, 3526, 3527, 3473		★
24 wells	24 well F-bottom	3300 µl	GREINER	662102, 662160		★
24 wells	24 well F-bottom	3350 µl	TPP	92024, 92424, 92124		★

To add new plates to the library, click on “Define new item”.

In the Configure Plate menu enter a unique name (e.g. well number and shape), the manufacturer and the part number of the plate.

The screenshot shows the 'Configure Plate' menu. On the left, there is a diagram of a plate with a grid of wells labeled A-H and 1-12. On the right, there are several input fields and controls:





- Add Plate Name:** A text input field.
- Manufacturer:** A text input field.
- Part Number:** A text input field.
- Description:** A text input field.
- Row Count:** A numeric input field set to 8.
- Column Count:** A numeric input field set to 12.
- Well Shape - Top View:** A dropdown menu set to 'Round'.
- Well Bottom:** A dropdown menu set to 'V-bottom'.
- Well Inner Diameter:** A numeric input field set to 8.00 mm.
- Center to Center Spacing - Rows:** A numeric input field set to 9.00 mm.
- Center to Center Spacing - Columns:** A numeric input field set to 9.00 mm.
- Offset Row 1:** A numeric input field set to 11.24 mm.
- Offset Column 1:** A numeric input field set to 14.38 mm.
- Plate Height:** A numeric input field set to 14.35 mm.
- Well Depth:** A numeric input field set to 10.00 mm.
- Plate Width:** A numeric input field set to 85.48 mm.
- Plate Length:** A numeric input field set to 127.76 mm.
- max. Well Volume:** A numeric input field set to 0 µl.
- Well V-shape Depth:** A numeric input field set to 0.00 mm.

**Note:** For plates in adapters, e. g. in PCR 96 or 384 well cooling plates, define the dimensions of the inserted plate in combination with the adapter as one plate.

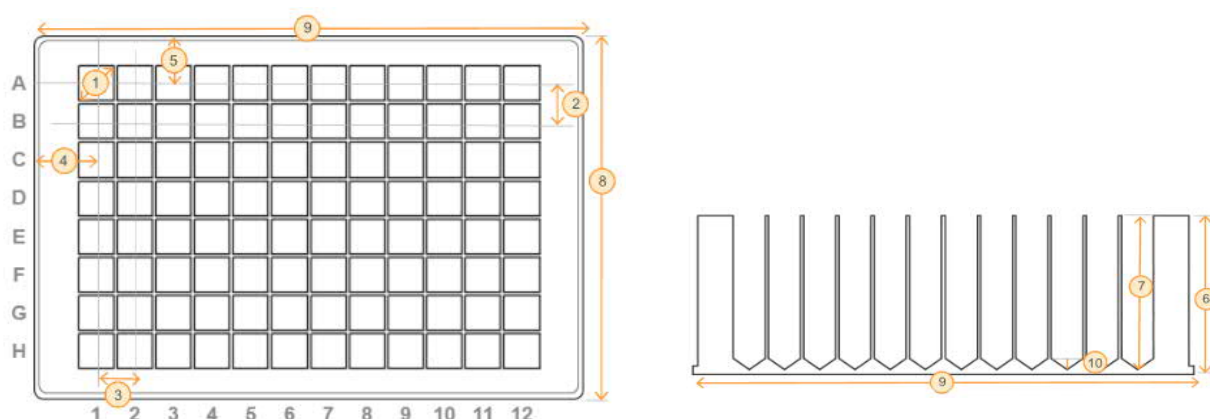
# INTEGRA

Enter all plate dimensions. You will be supported by live drawing of the defined plate.



Dimension	Description
Row Count	A 96 well microplate is arranged as 8 rows by 12 columns.
Column Count	A 384 well microplate is arranged as 16 rows by 24 columns.
Well Shape - Top View	Shape on the top of the well, is usually round.
Well Bottom	 U-bottom = round
	 F-bottom = flat
	 C-bottom = curved edges of flat bottom, e. g. for easy wash
	 V-bottom = conical
Well Inner Diameter	Well diameter (1) on the top of the well
Center to Center Spacing - Rows	The distance between the rows (2) /columns (3) from the middle of one well to the middle of the next well.
Center to Center Spacing - Columns	96 well: ANSI/SLAS-standard <sup>1</sup> : 9 mm 384 well: ANSI/SLAS-standard: 4.5 mm
Offset Row 1	The distance between the top outside edge of the plate and the center of the first row of wells (4).
	96 well   ANSI/SLAS-standard: 11.24 mm
	384 well   ANSI/SLAS-standard: 8.99 mm
Offset Column 1	The distance between the left outside edge of the plate and the center of the first column of wells (5).
	96 well   ANSI/SLAS-standard: 14.38 mm
	384 well   ANSI/SLAS-standard: 12.13 mm
Plate Height	Plate height (6). ANSI/SLAS-standard: 14.35 mm ± 0.76 mm
Well Depth	Depth in the center of the well (7).
Plate Width	The shorter side (8), ANSI/SLAS-standard: 85.48 mm ± 0.5 mm
Plate Length	The longer side (9), ANSI/SLAS-standard: 127.76 mm ± 0.5 mm
max. Well Volume	The total, calculated well volume, not the working volume
Well V-shape Depth	Depth from start of conical narrowing to well bottom only for V-bottom wells (10).





<sup>1</sup> ANSI: American National Standards Institute, SLAS: Society for Laboratory Automation and Screening.

## 7.3 Tube Rack

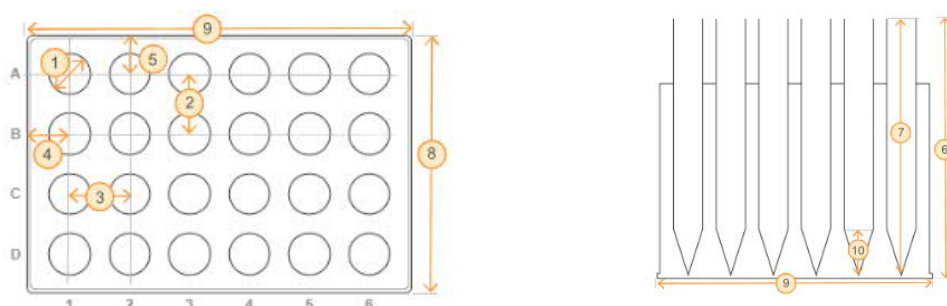
To create new tube racks, select Tube Racks and click on “Define new item”. In the Configure Tube Rack menu enter a unique name, the manufacturer, the part number and a description, if applicable.

Enter all tube rack dimensions and the tube type. You will be supported by live drawing of the defined rack.



Dimension	Description
Row Count	Number of rows.
Column Count	Number of columns.
Tube Shape - Topview	Shape on the top of the tubes, is usually round.
Tube Shape - Bottom	 U-bottom = round
	 F-bottom = flat
	 C-bottom = curved edges of flat bottom
	 V-bottom = conical, including typical conical tube form with round bottom
Tube Inner Diameter	Tube inner diameter <b>in the middle</b> of the tube (1).
Center to Center Spacing - Rows	The distance between the rows, from the middle of one tube to the middle of the next tube (2).
Center to Center Spacing - Columns	The distance between the columns, from the middle of one tube to the middle of the next tube (3).
Offset Row 1	The distance between the top outside edge of the rack and the center of the first row of tubes (4).
Offset Column 1	The distance between the left outside edge of the rack and the center of the first column of tubes (5).
Tube Rack Height	Total height of tube rack and tubes (6).
Tube Depth	Depth in the center of the tube (7).
Tube Rack Width	Width of the rack(8). ANSI/SLAS-standard: 85.48 mm ± 0.5 mm.
Tube Rack Length	Length of the rack (9). ANSI/SLAS-standard: 127.76 mm ± 0.5 mm.
Max. Tube Volume	The total, calculated tube volume, not the working volume.
Tube V-shape Depth	Depth from start of conical narrowing to tube bottom, e. g. 3.1, only for V-bottom wells (10).



## 7.4 COMBI Base

A COMBI Base is a platform where a module, i.e. a reservoir, plate or tube rack, can be placed on. It only acts as an adapter and you cannot choose a COMBI Base alone as a pipetting location (only a COMBI System see chapter 7.5)

To create a new COMBI Base, select COMBI Base and click on “Define new item”. In the Configure COMBI Base menu enter a unique name, the manufacturer, the part number of the COMBI Base and a description, if applicable.

Enter all COMBI base dimensions. You will be supported by live drawing of the defined COMBI base.

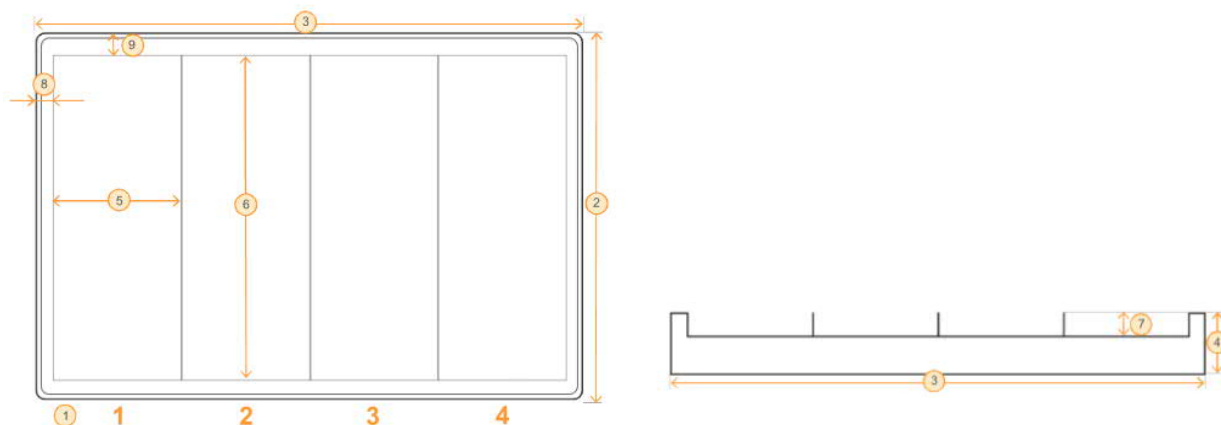

Dimension	Description
Division	<b>Regular:</b> a repeated number of identical sections are lined up. <b>Irregular:</b> sections are positioned freely within the outer dimensions of the base.
Sections	Number of sections (1).
Base Width	Width of the base (2). ANSI/SLAS-standard: 85.48 mm ± 0.5 mm.
Base Length	Length of the base (3). ANSI/SLAS-standard: 127.76 mm ± 0.5 mm.
Base Height	Total height of the base (4).
Sections Width	The width of a section (5).
Section Length	The length of a section (6).
Section Height	The height of a section (7). Negative values indicate that the bottom of the section is deeper than the whole COMBI base.
Left edge offset of section	The distance between the left outside edge of the base and the left edge of the first section, including the bottom outside flange (8).
Top edge offset of section	The distance between the top outside edge of the base and the top edge of the first section including the bottom outside flange (9).

## 7.5 COMBI System

A COMBI System consists of a COMBI Base and individual modules, i.e. a reservoir, plate or tube rack, which are placed on the COMBI Base.

To create a new COMBI System, click on “Define new item”. In the Combine COMBI System menu select a COMBI Base.

Enter a unique name, the manufacturer, the part number and a description of the COMBI System, if applicable.

The screenshot shows the VIALAB 2.0 software interface for defining a COMBI System. The main window is titled "Slider Adapter\_System" and includes a "Save COMBI System" button. The interface is divided into several sections:

- Top Bar:** Includes the VIALAB 2.0 logo, a "COMBI System: Select a module" label, an "Open Help" button, and a "Library" icon.
- Live Drawing:** A central area showing a live drawing of a COMBI Base with a selected module (a tube rack) highlighted in orange.
- Module Selection Panel:** A panel on the right with checkboxes for "Plates", "Tube Racks", and "Reservoirs". A dropdown menu is set to "All", and there is a "Part Number" input field and a star icon.
- Module Library Table:** A table listing available modules with columns for Name, Manufacturer, Part Number, Description, and Favorites.

	Name	Manufacturer	Part Number	Description	Favorit...
	Slider 0.5 ml microcentrifuge tubes	INTEGRA		Slider for 0.5 ml microcentrifuge tubes (see PN 4541)	★
	Slider 1.5 ml microcentrifuge tubes	INTEGRA		Slider for 1.5 ml microcentrifuge tubes (see PN 4540)	★
	Slider 2 ml microcentrifuge tubes	INTEGRA		Slider for 2 ml microcentrifuge tubes (see PN 4540)	★

- 1 **Name:** Unique name under which the COMBI system is stored.
- 2 **Save COMBI system:** Save button.

Click in a section and select a Module. Continue with the next section until all sections are filled. You will be supported by live drawing of the defined COMBI System.

Click on Save COMBI System.

## 8 Trouble Shooting

Topic	Issue	Remedy
Labware Library	I cannot place my labware item on the deck, although it is defined correctly in the labware library.	<ul style="list-style-type: none"> <li>• Make sure the selected labware item is compatible with your pipette.</li> </ul>
		<ul style="list-style-type: none"> <li>• Make sure your labware item fits to the selected deck position e.g. a tube rack cannot be placed on deck position A.</li> </ul>
Labware Library / Method	I created my labware item and placed it on the deck, but I cannot fill it with volume.	<ul style="list-style-type: none"> <li>• Make sure the Max. Well Volume is &gt; 0 µl.</li> </ul>
Connection between pipette and computer	I cannot get a connection between pipette and VIALAB.	<ul style="list-style-type: none"> <li>• Make sure the pipette is in communication mode (see chapter 6.5.1.)</li> <li>• Make sure the Programming Stand or device is connected to the computer.</li> <li>• Bluetooth: The pipette Bluetooth module and PC need to be paired if connected for the first time. Refer to Windows Help to learn how to pair Bluetooth devices. The passcode 12345 may be required.</li> <li>• Make sure the drivers for the Programming Stand are installed. While the Programming Stand is connected, go to your System Settings -&gt; Device Manager. Check under Ports (COM &amp; LPT) if there is an entry "USB Serial Port (COM X)". If there is not, install the drivers manually.</li> </ul>
Synchronization of programs from pipette to VIALAB.	The "Synchronize" button is not activated.	<ul style="list-style-type: none"> <li>• Make sure that no changes were made in VIALAB after saving the program to the pipette.</li> </ul>
Pipette status in section Transfer.	I connected the pipette and its status is "Pipette is incompatible".	<ul style="list-style-type: none"> <li>• Make sure that the correct pipette model matching the current program is connected. You can only transfer programs to the pipette model used in the program.</li> </ul>
Program Transfer To Pipette	The pipette is connected, after "Send To Pipette" the program is not saved on the pipette.	<ul style="list-style-type: none"> <li>• Make sure, that you do not use any special characters in your program name on the pipette (Transfer Screen).</li> </ul>